

A POPULAR GUIDE TO BUILDING A
COMMUNITY FM BROADCAST STATION

\$6.00

Have you ever thought about setting up a small FM broadcast station for your community and considered such an endeavor much too involved and expensive? This book demonstrates that it is not - and, it will inspire you to make the effort. Of all the media and communications technologies, radio is the most accessible and democratic. By asserting your right to communicate, you become part of the struggle for free speech, resisting the privatization of yet another public resource, the broadcast airwaves. If you can not communicate, you can not organize; if you can not organize, you can not fight back; and, if you can not fight back, you have no hope of winning.

This book was illustrated and written by T.J. Enrile in conjunction with Free Radio Berkeley. T.J. is a student in Multimedia Studies at Diablo Valley College in Pleasant Hill, California.



ISBN 0-9771152-0-8

50600



9 780977 115204

A POPULAR GUIDE TO...

**BUILDING
FM BROADCAST
STATION**
A COMMUNITY...

Written & illustrated
By T.J. Enrile



WATT'S LAW & Ohm's LAW PIE CHART
for electronics technicians

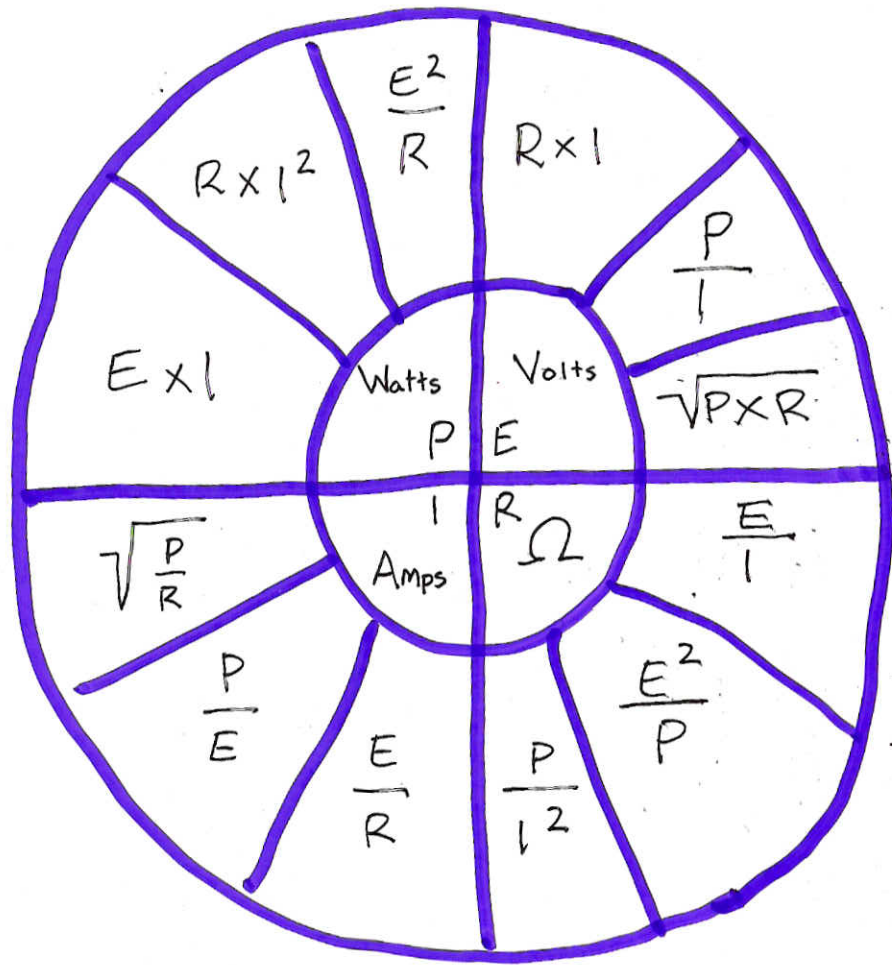

P = power in Watts W
 E = voltage in Volts V
 I = current in Amps A
 R = resistance in Ohms Ω

Now that you have been inspired to set up a micropower broadcast station, this addendum will provide you with further details to assist your endeavors.

One of the first questions commonly asked is "How far will the signal go for a given power level?". Unfortunately there is not an exact answer to this question. It is a function of antenna height, power level and local topography. Obviously, 40 watts with a antenna height of 50-60 feet is going to go much further in Kansas than in Manhattan. The following chart assumes relatively flat terrain, low rise buildings and an antenna height in the range of 50-70 feet.

Power level	Maximum distance
1 watt	2-3 miles
10 watts	4-5 miles
50 watts	8-10 miles
100 watts	10-14 miles

Another question is, "How do I choose a frequency". The FM broadcast band is broken up into channels which take up a certain amount of spectrum space. You need to choose a frequency that does not have an intelligible signal on that channel nor one on either side of it within the area you wish to cover. For example, if you found that 101.5 was clear, then 101.3 and 101.7 must be clear as well. In urban areas it may be hard to meet these conditions but do the best you can. Driving around in a car with a digitally tuned radio is a good way to survey an area for an open spot.

Cost of setting up a station is always a concern. Depending on whether you build your own transmitter from a kit or purchase one already assembled and the type of audio equipment you choose, the cost can range from \$500-\$1500. Free Radio Berkeley, the publisher of this book, provides a full range of transmitter kits, antennas, cabling, audio equipment and complete plug and play station packages. Other vendors of equipment can easily be found by searching the internet.

In addition, Free Radio Berkeley offers 4 day radio camps on a regular basis. During the 4 day period you will actually build an FM broadcast transmitter and learn how to set up a broadcast station. These camps are held at Free Radio Berkeley's facility in Oakland, California. Camps can be scheduled at other locations, both inside and outside the US, by prior arrangement. A volunteer/apprentice program is offered to anyone who wishes to take several weeks or longer to work and learn at the Oakland facility. For full technical detail go to the FRB web site (www.freeradio.org) and download the Micropower Broadcasting Primer.

Contact Free Radio Berkeley for additional information.

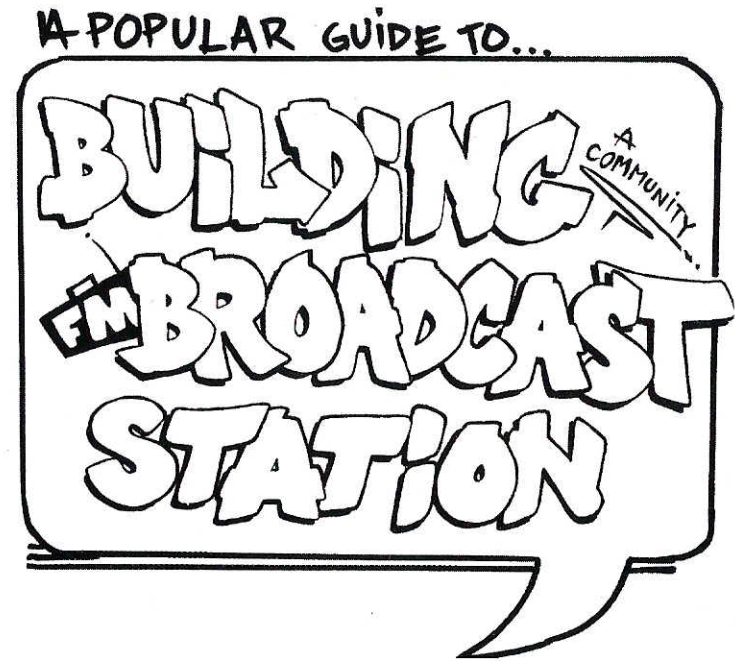

by T.J. Enrile

APRATED BY V.F.O. (voice s of free olympia)

©Copyright: 2005 Free Radio Berkeley

ISBN 0-9771152-0-8

Published by:

Free Radio Berkeley
Can of Worms Publishing
1442A Walnut St. #406
Berkeley, California
94709
www.freeradio.org
freeradio@riseup.net
510-625-0314

"Unlicensed broadcasting creates chaos on the airwaves. It's anarchy on the airwaves.... Your honor this opens up such a can of worms"
-FCC attorney David Silberman, first FRB court hearing 1/20/1995

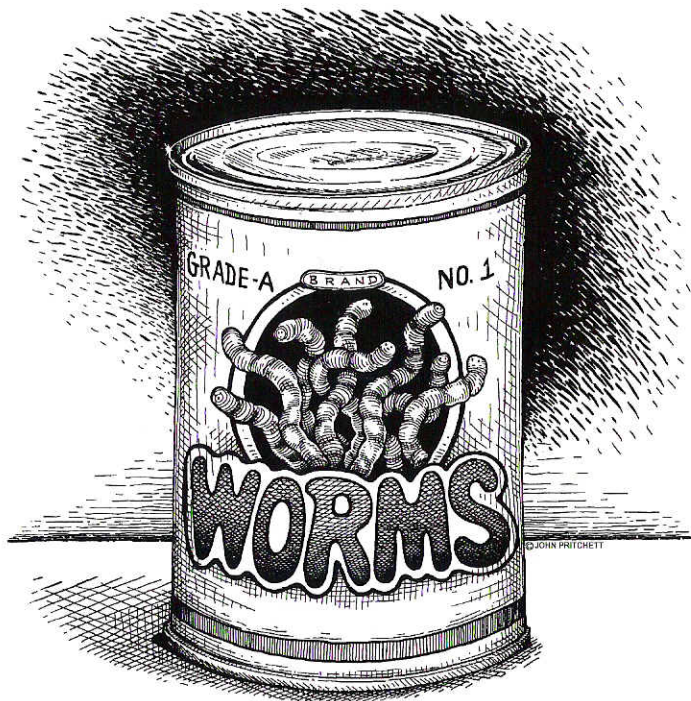

"Experience has shown that once the technical operation is in place and running, it will require very little in the way of intervention except for routine maintenance (cleaning tape heads, dusting, etc.) and occasional replacement of a tape or CD player."

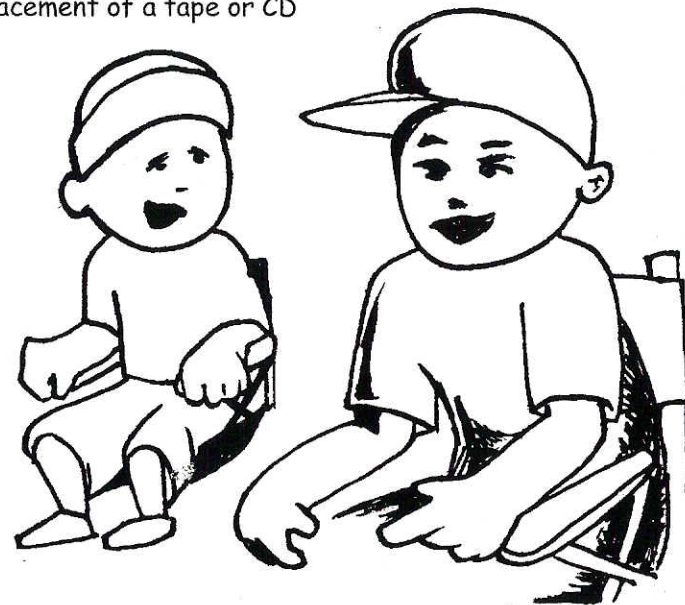

"What requires most attention and "maintenance" is the human element, however. More time will be spent on this than any equipment. As a survival strategy it is best to involve as much of the community as possible in the radio station. The more diverse and greater number of voices the better. It is much easier for the FCC to shut down a "one man band" operation than something serving an entire community. Our focus is on empowering communities with their own collective voice, not creating vanity stations. Why imitate commercial radio?"



Before you commit to your first broadcast it would be advisable to have an attorney available who is sympathetic to the cause. Even if they may not be familiar with this aspect of the law, there are plenty of briefs and other materials that will bring an attorney up to speed.

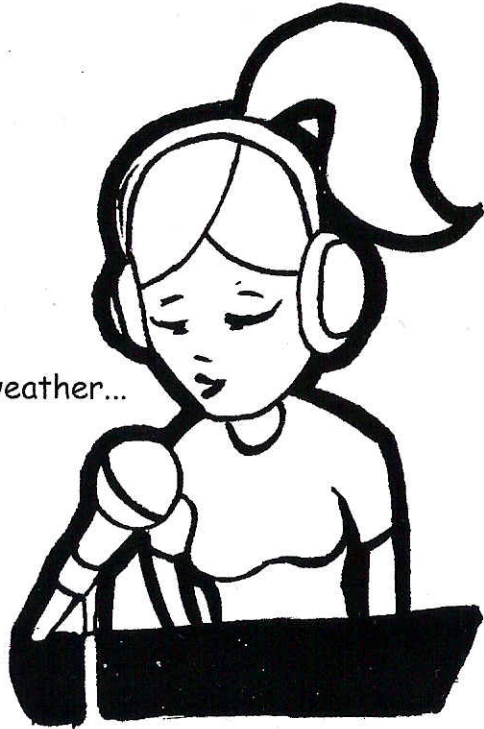

...And today's weather...

Table of contents

Hey, we should build a radio station	1
What equipment is needed?	3
Finding a location	9
how to build a simple no-tune antenna	12
The layout	13
Testing a transmitter, tuning an antenna	15
setting up the limiter compressor	19
Some final words	23

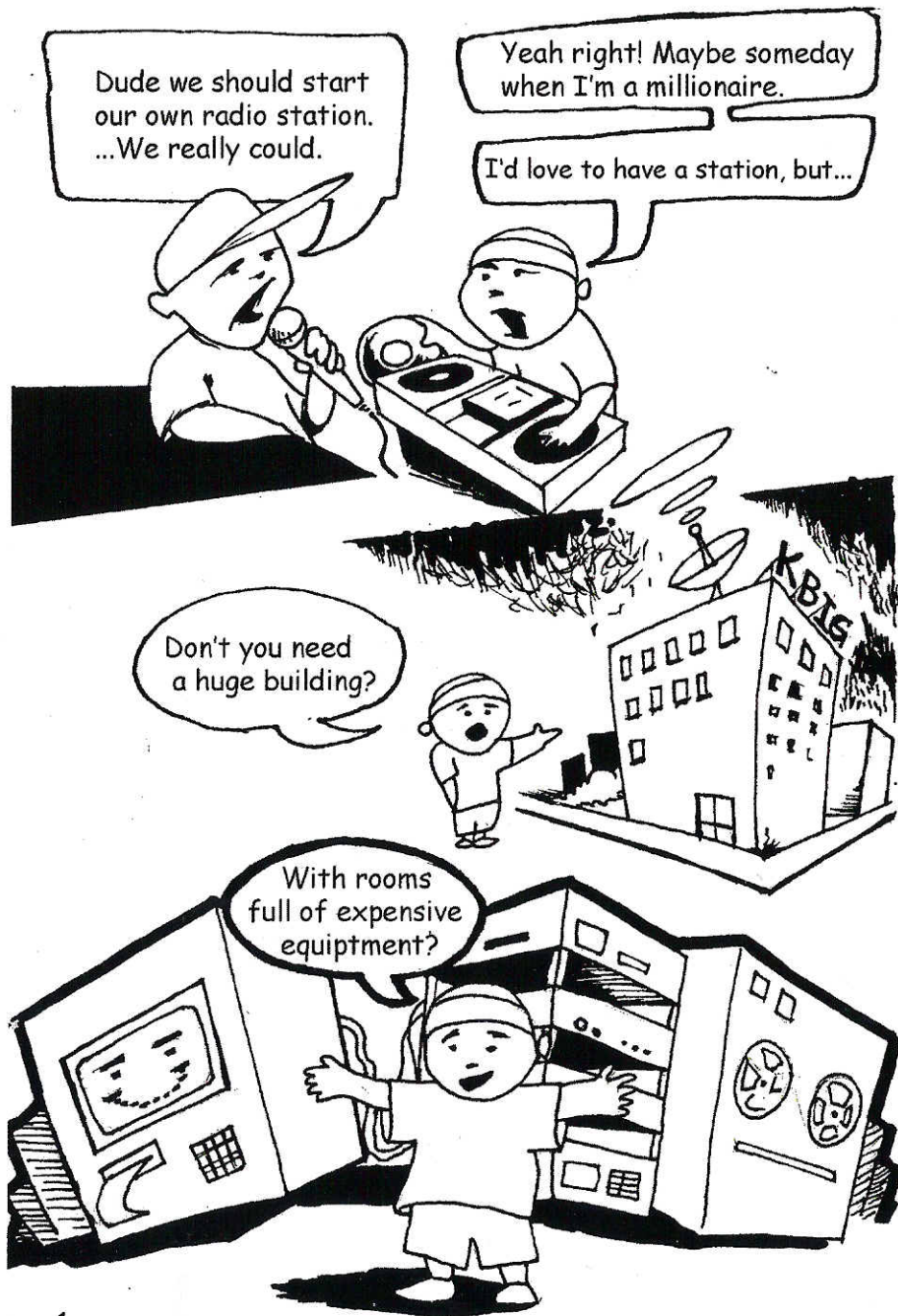

③ Compare your signal to other stations. And adjust the level of your signal to be slightly less in volume

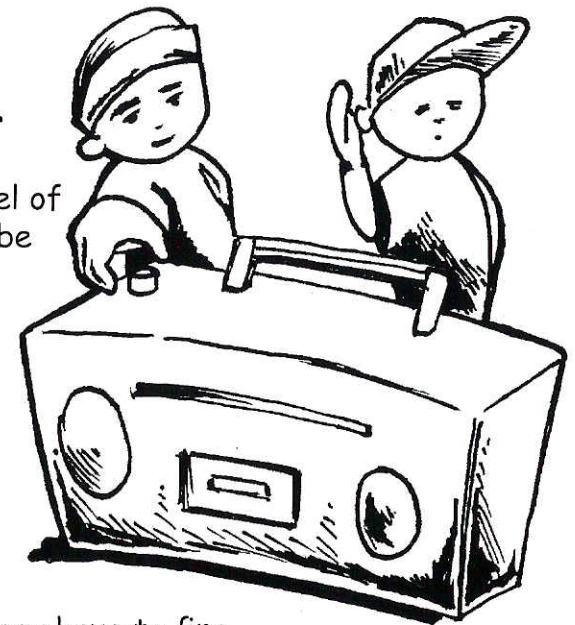

You may have to fine your limiter/compressor



When everything is set correctly there should not be any splattering or distortion of the signal. Listen very carefully for high level audio. Some interplay between the output and threshold should fix it. When everything sounds good - Abracadabra! You are ready to broadcast.

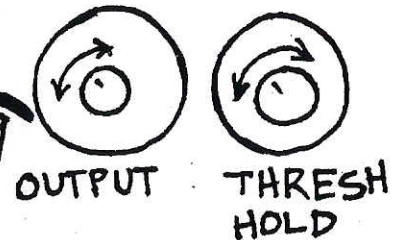

Wait up! Just one more thing before you turn on the transmitter.

- ① make sure the input on the limiter/compressor is turned all the way down to zero.
- ② Now, on a good quality radio that is set to your station, slowly turn up the input level on the limiter/compressor until you hear your test tone.

Now go ahead and turn on the transmitter.



No, I don't have hundreds of thousands of dollars, but ... we actually don't need all that stuff. Because we are gonna build a micropower broadcast station. Our equipment will be smaller and very affordable. Our transmitter will be about the size of a brick. With that and a few other components our studio could be the size of a closet. The total cost for the entire station is \$1000 to \$1500.



Really? Wow. So, what equipment do we need?



WHAT IS NEEDED

A

microphone(s)

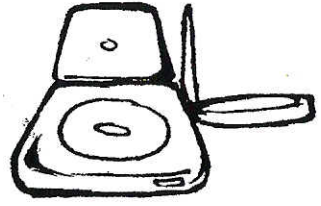
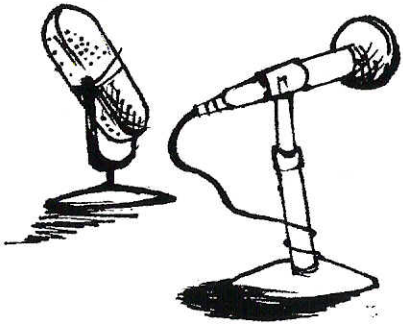

CD players

an audio mixer

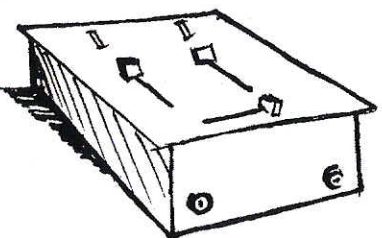

tape deck(s)

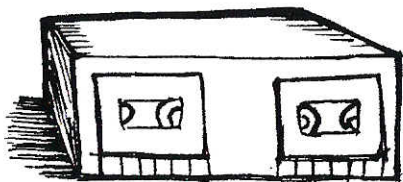

Adjust the output level so the output indicator shows zero output level

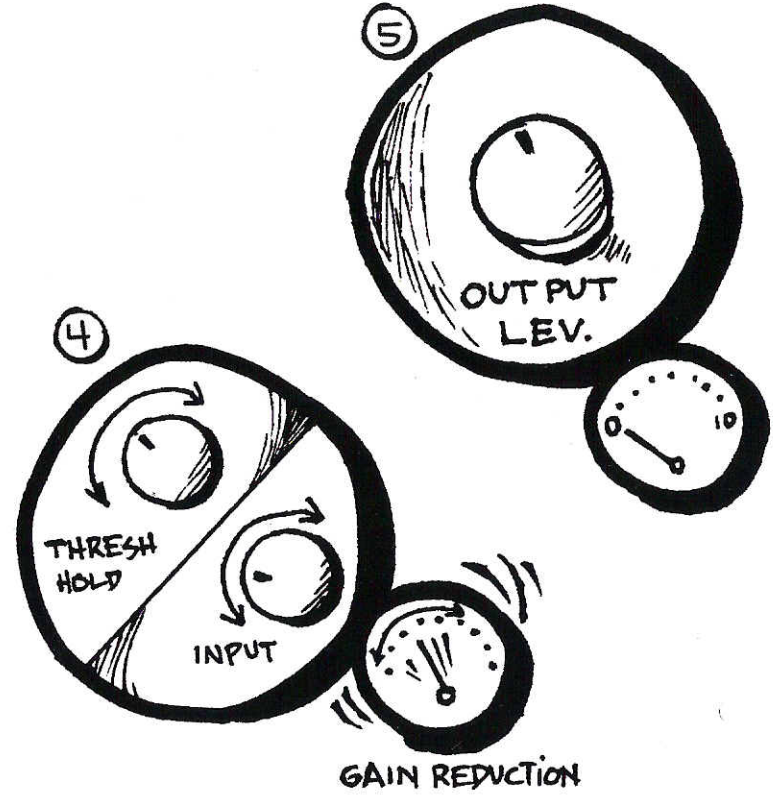

Adjust the threshold and input level so that the gain reduction indicator shows activity

Like we said before, the limiter/compressor is very important because it prevents signal splatter and distortion. To properly set up the mixer, limiter/compressor and transmitter, start with a steady audio source (a test tone CD or signal generator plugged into the mixer). Then you adjust the input level and master output level controls so that the meters are reading zero dB. Master level controls should be at mid position. Audio output goes from the mixer to the limiter/compressor and from there to the transmitter. Do not turn the transmitter on yet.

TO CREATE RADIO STATION?

limiter/compressor



antenna

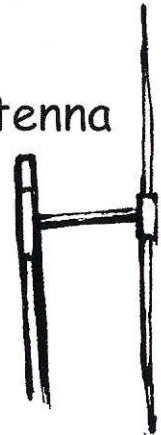

transmitter



coaxial cable

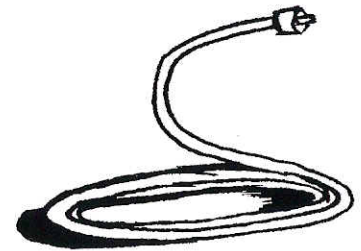

power supply

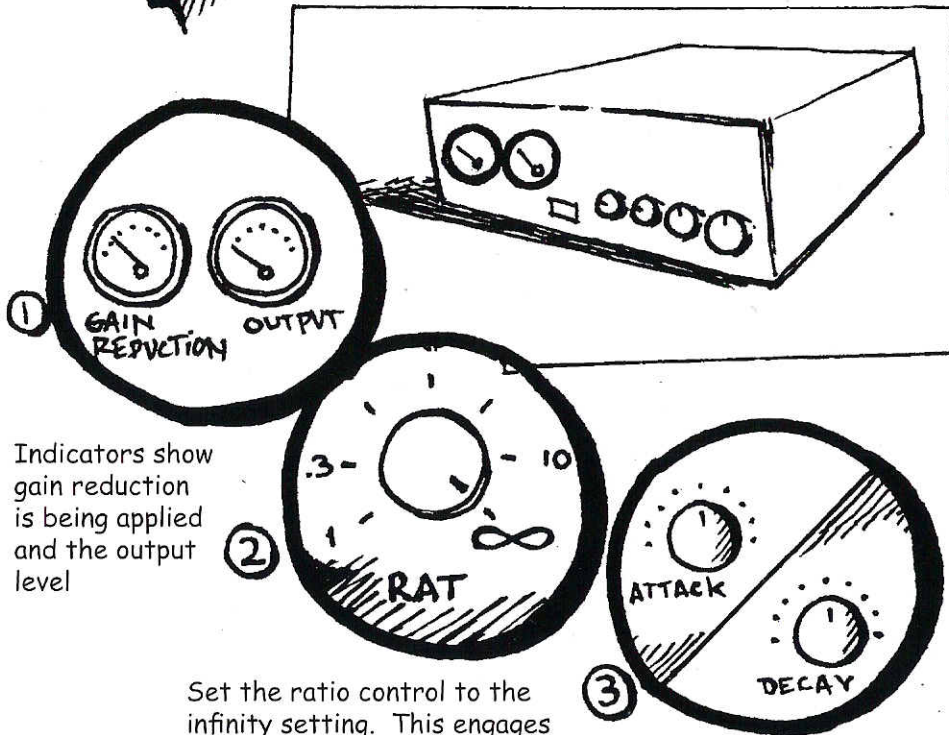
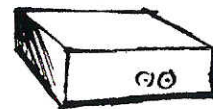

Indicators show gain reduction is being applied and the output level

1 Set the ratio control to the infinity setting. This engages the hard limit function

2 Set the attack and decay at mid position



and then, fine tune the antenna

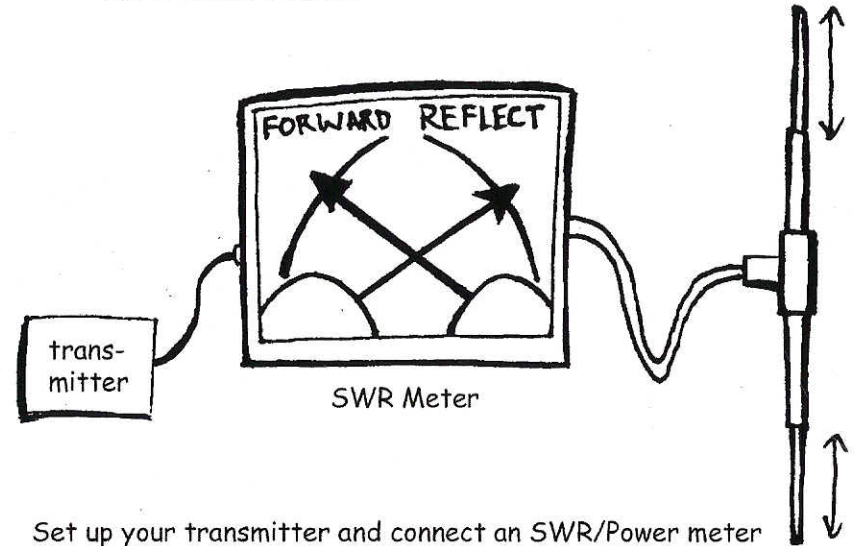

Set up your transmitter and connect an SWR/Power meter between the transmitter and the antenna. Adjust your meter to read SWR according to the directions that came with it. SWR is the ratio of power coming from the transmitter and the power reflected back from the antenna. A properly tuned antenna will reflect very little power back, resulting in a very low SWR ratio. Too much reflected power can damage the transmitter.

Turn on the transmitter and observe the SWR or amount of reflected power. Shut the transmitter off if the level is very high and check your connections. Rough tuning the antenna by measurements should have brought the readings down to a fairly low level. Turn off the transmitter and adjust each tubing stub up or down about 1/4 of an inch. Turn the transmitter back on and note the readings. If the reflected power and SWR ratio went lower you went the right direction in either increasing or decreasing the length of the stubs. Turn off the transmitter and continue another 1/4 inch in the same direction or the opposite direction if the SWR ratio and reflected power increased. Turn the transmitter on again. If the reading is lower continue to go in the same direction in 1/4 inch increments being sure to turn off the transmitter to make the adjustments. Continue to do this cycle until you have reached the lowest possible reading. At some point the readings will start to increase again. Stop there, You have hit the sweet spot.

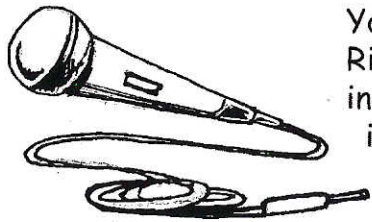

You know what a **microphone** is . Right? You plug them in and talk into them. You can use a low impedance one for broadcasting, but most any one will work .

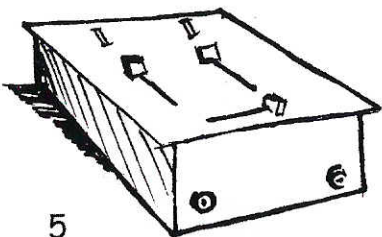

a **mixer** is what you plug all your microphones, cd players, and audio stuff into, then it mixes it into one output. use a mixer that fits your needs.



rough tune the antenna first

"It's time for a little bit of math! Don't worry it's just a tiny bit, I swear."

An antenna is rough tuned by adjusting the length of the radiating element(s). Many antenna designs are based on or derived from what is called a dipole, two radiating elements whose length is roughly equivalent to $1/4$ of the wavelength of the desired frequency of transmission. Wavelength in inches is determined by dividing 11811 by the frequency in megahertz. The result is either divided by 4 or multiplied by .25 to yield the $1/4$ wavelength. A correction factor of .9 to .95, depending on the diameter of the element, is multiplied times the $1/4$ wavelength resulting in the approximate length of 17 each element.

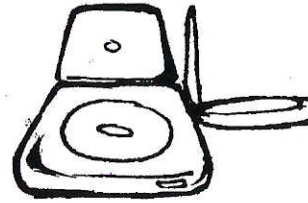

CD players and Tape decks can be your average higher quality consumer audio gear. Day in and day out use will eventually take their toll so pay for the extra warranty period when it is offered. When one wears out in 6 months or so just take it back under warranty for either repair or replacement.

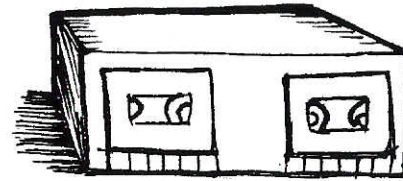

A limiter/compressor is required to prevent over modulation of the FM signal. Over modulation will cause spurious emissions and interference with other signals plus sound very distorted. It is extremely important to prevent this.

A **transmitter** is the piece of equipment that turns your audio signal into an FM broadcast signal. Transmitters for micropower broadcasting have a typical output power range of 1 to 100 watts.

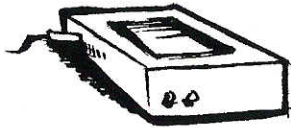

A **power supply** supplies the transmitter with the correct DC voltage, typically either 12-14 volts or 28 volts. The power supply transforms AC wall voltage into the correct DC voltage. Electrical capacity of the power supply is measured in amps. Be certain that the power supply has enough capacity for the transmitter being used.



You can use a 12 volt lead acid battery for portable set-ups or connect directly to an automotive electrical system through the cigarette lighter socket.

An **antenna's** purpose is to radiate the FM broadcast signal from the transmitter to surrounding FM radio receivers. In order to do this the antenna must first be tuned to the frequency being transmitted. You will need a SWR meter to tune it, but we will get to that later. Secondly, the antenna must be sited and oriented properly.

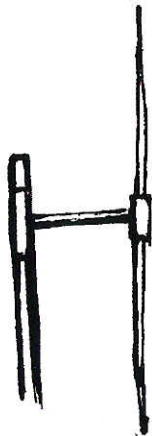

How to test your transmitter

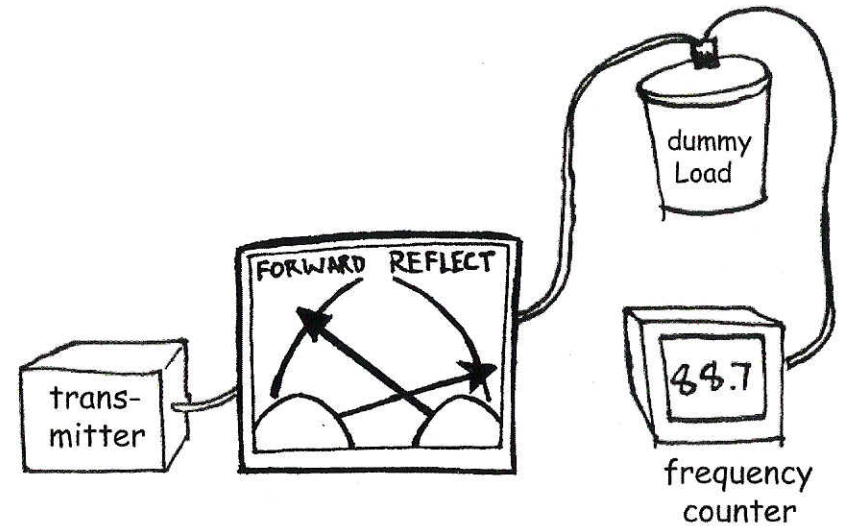

Transmitters, particularly their construction and tuning, should be left to an experienced person. If such a person is not available there are a number of people who will assemble, test and tune your transmitter for whatever fee they have set.

You can test your transmitter by connecting it to an SWR or power meter, a dummy load and a frequency counter as shown.

Since the dummy load simulates an ideal antenna the SWR meter should show little or no reflected power and the forward shows how much power is being put out by the transmitter. The frequency counter will display your desired operating frequency.

These are some other accessories you will need for the tuning and testing of the transmitter and limiter compressor.



Always use a **dummy load** when testing and tuning transmitters and amplifiers. A dummy load is a non-inductive resistive load which simulates an ideal antenna impedance of 50 ohms. Never use an antenna for testing and tuning transmitters.

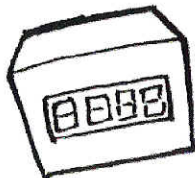

To accurately maintain your operating frequency a **digital frequency counter** is highly recommended.

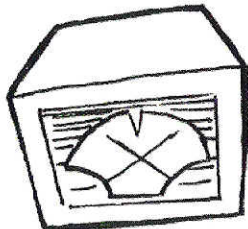

An **SWR/power meter** is essential to the proper tuning and setting up of transmitters and antennas. An antenna has to be fine tuned so that it accepts the full power of the transmitter and reflects the lowest amount possible back, that ratio of forward power to reflected power is known as the standing wave ratio (SWR). The various stages of both transmitters and amplifiers have adjustable capacitors which are used to

tune the unit to the frequency of operation. A power meter allows you to see the effect of these adjustments on the power level and to set everything at optimum level.

A **Coaxial Cable** is a special type of wiring that has an inner conductor surrounded by an insulating plastic sheath which is covered by a braid of copper wire that is then covered by a plastic jacket. They are like the ones that are used to hook up cable to your TV set. But those are 75 ohm, since we are using ours for radio frequency we will need to use **50 ohm** cable.

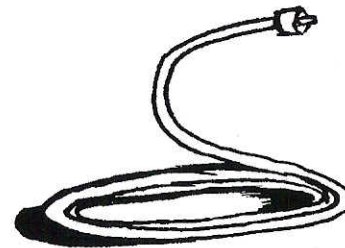

I'm gonna be like,... today's weather is - wait, let me look out my window... It's good!

I can't wait.

yeah, me neither. let's find a location



Finding a location for the antenna...



The top or side of a hill overlooking the area of coverage is best.

FM transmission is "line of sight" meaning, the transmitting antenna and receiving antenna must be able to "see" each other.

So, if there are any large obstructions it might block the signal path. We should keep that in mind.

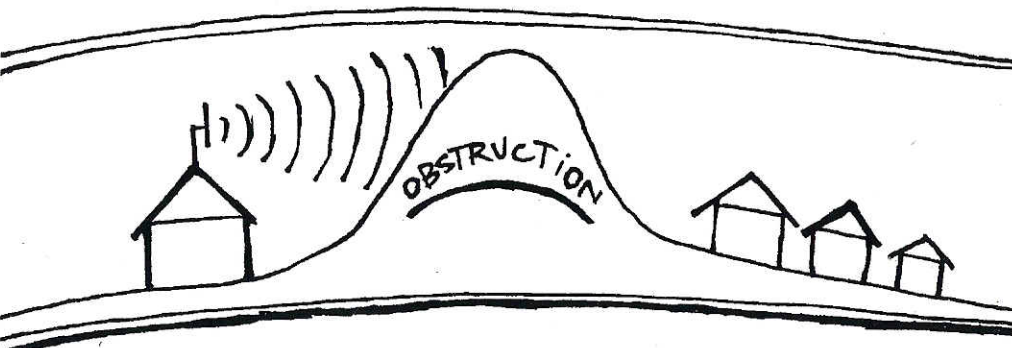

Strap the antenna to the mast with the supplied clamps.

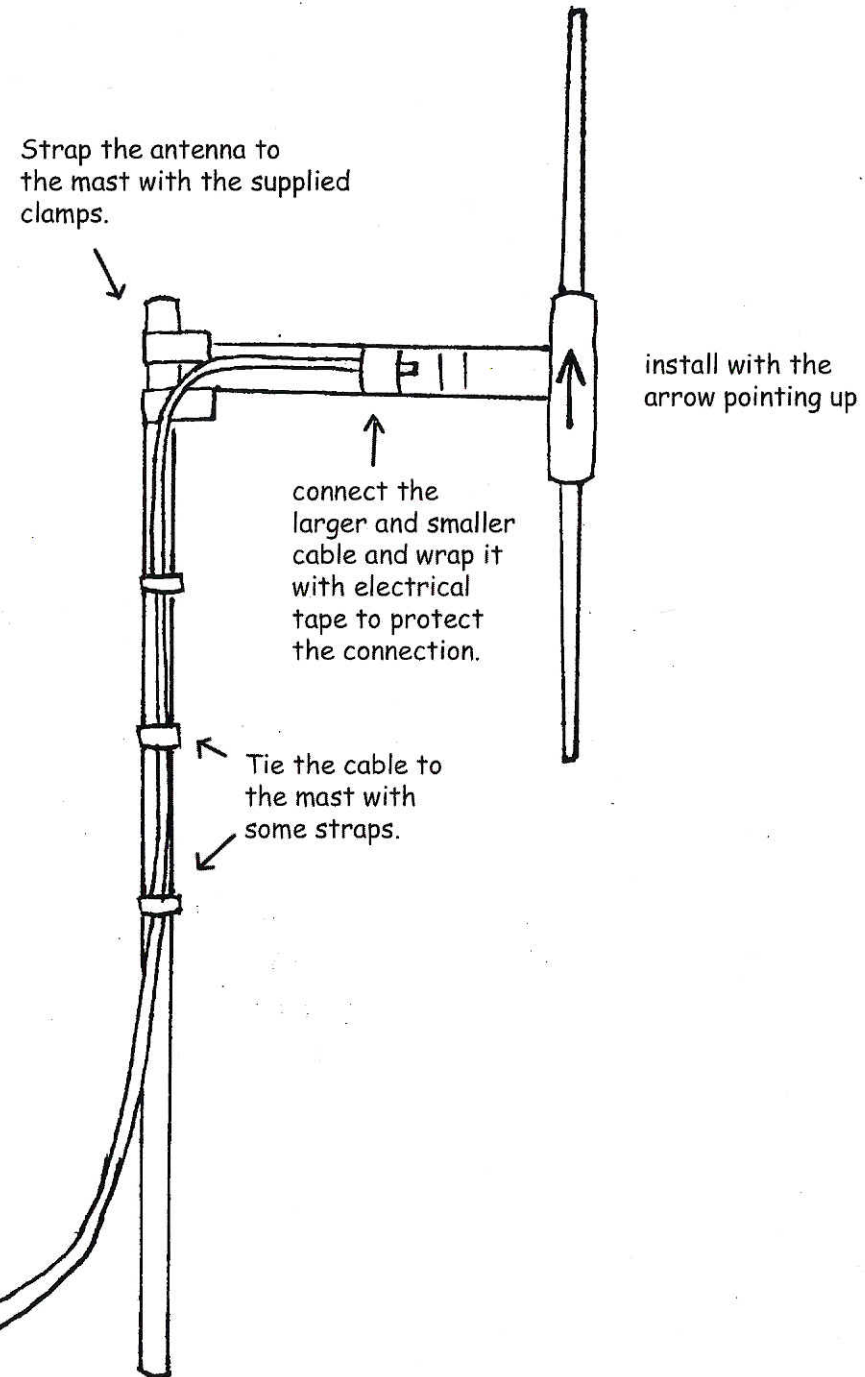

install with the arrow pointing up

connect the larger and smaller cable and wrap it with electrical tape to protect the connection.

Tie the cable to the mast with some straps.

(remember not to sharply bend the coax cable)

the Layout...

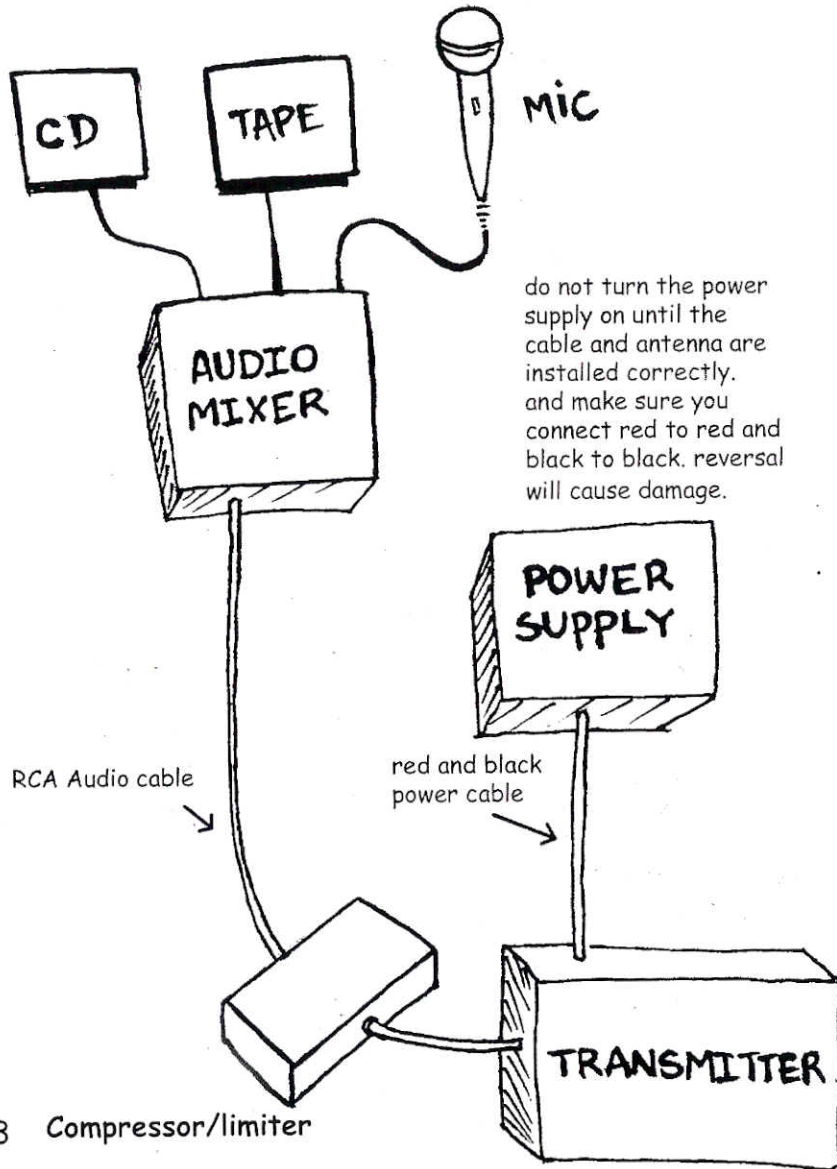

do not turn the power supply on until the cable and antenna are installed correctly, and make sure you connect red to red and black to black. reversal will cause damage.

If your site is a 1-3 story building, a 30 foot push up style mast attached and guyed to the roof or a TV antenna style tower bracketed to the side of the building will be needed to provide adequate height to the antenna. You need to have the antenna at least 40-50 feet above the ground.

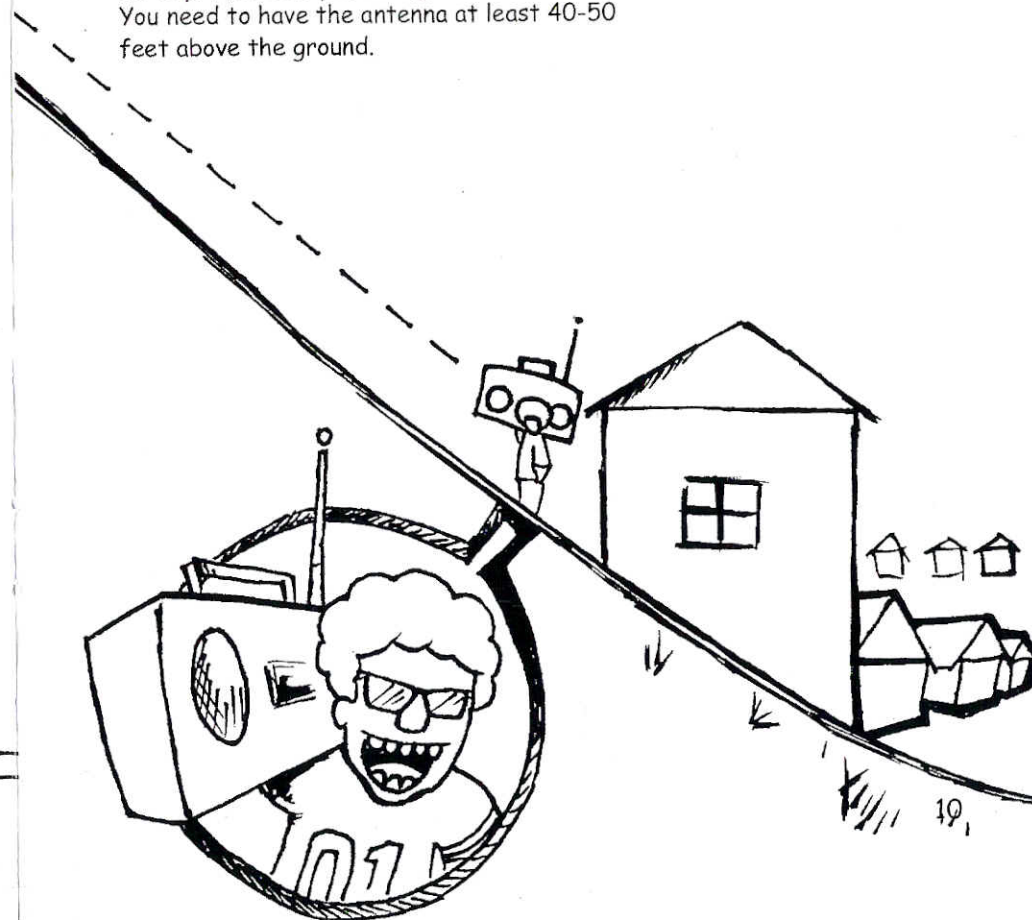
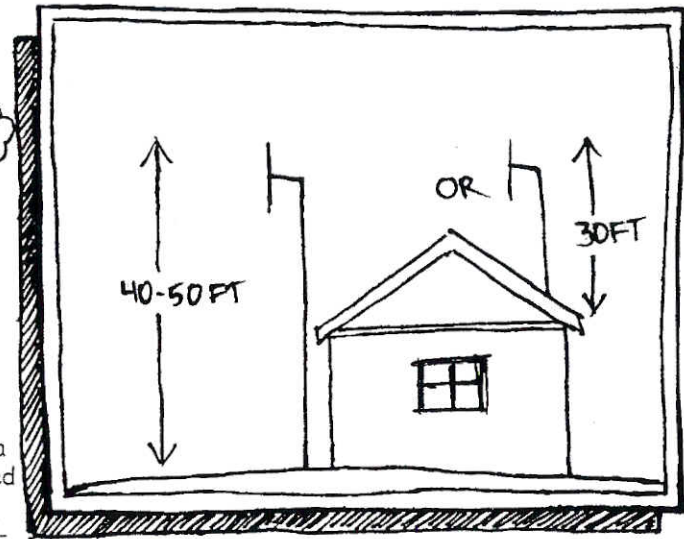

One more thing... it's good to keep the transmitter far away from the audio equipment, perhaps in another room or attic space since radio frequency emissions from the transmitter can get into the audio equipment and cause noise and hum.

the transmitter should be far away from the audio equipment, but as short a distance to the antenna as possible to avoid signal loss in the coaxial cable that feeds the antenna.

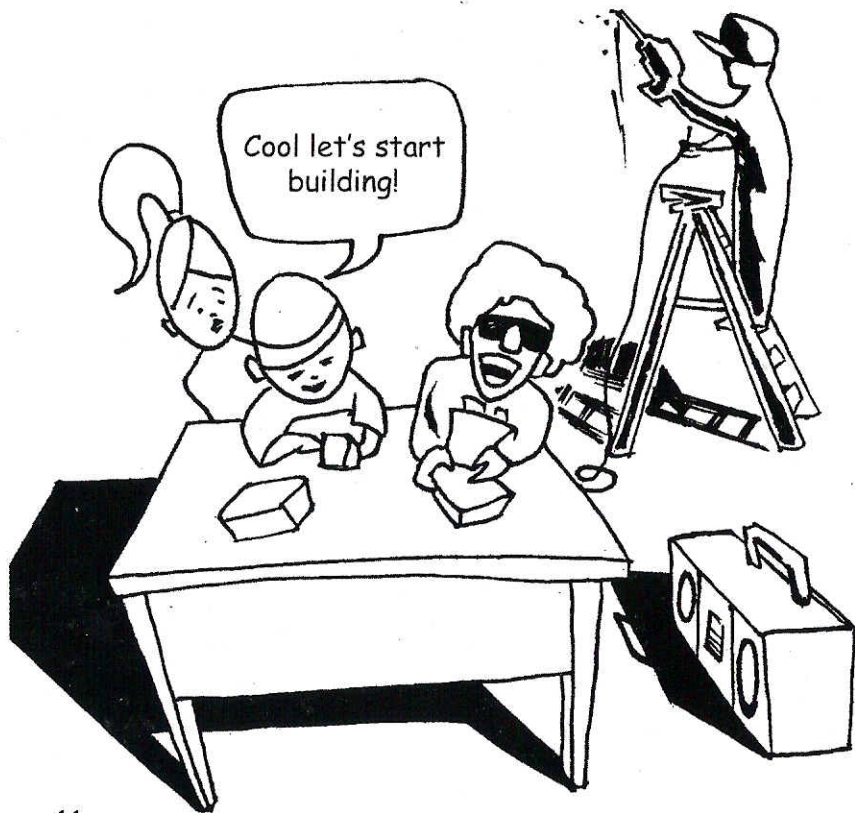
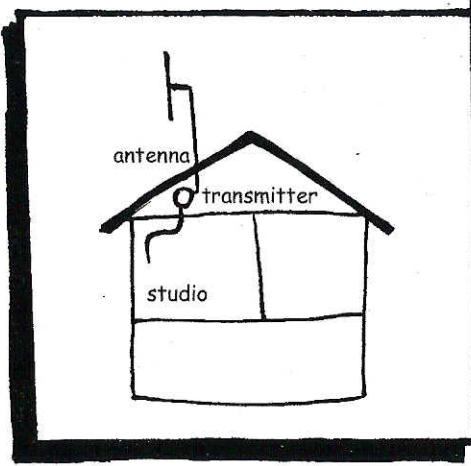

Here's how you can make a simple "no-tune dipole antenna" out of some things you can find at any hardware store. It doesn't require any tuning because it works over the entire band instead of a specific frequency.

You need:

6" diameter vent pipe

an 8 ft. length 1.5" or 2" diameter PVC

and some self tapping screws

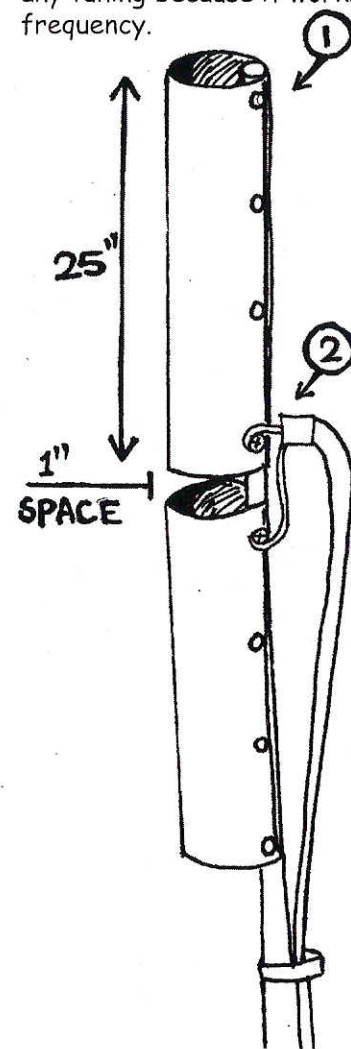
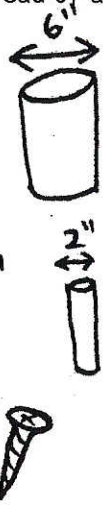

1. You need two 25" lengths of the 6" vent pipe. Then put the through one of the vent pipes and secure the vent pipe to the PVC with self tapping #8 sheet metal screws along the length. Leave the screw closest to the inch gap slightly unscrewed, one conductor of the coaxial cable will attach to it. Repeat this process with the second vent pipe and leave a 1 inch space between them
2. Obtain a 50-75 foot RG211 coaxial cable with PL259 plugs. Cut one of the plugs off. About 2 inches from the end of the cut end of the coax, cut through the outer jacket, the braid and the insulation covering the center-conductor but do not nick it. Remove these outer layers to expose the center conductor. Next, remove about 1 inch of the outer plastic to expose the braid. Take a 8 inch piece of #18 copper wire and wrap several turns around the braid. Solder it to the braid. Connect the inner conductor to the upper pipe and the wire attached to the braid to the bottom pipe. Be certain they do not short together. Cover the exposed connections and wires with hot melt glue or silicone sealant. The end with the remaining plug will connect to the transmitter. Use cable ties for strain relief.

Remove these outer layers to expose the center conductor. Next, remove about 1 inch of the outer plastic to expose the braid. Take a 8 inch piece of #18 copper wire and wrap several turns around the braid. Solder it to the braid. Connect the inner conductor to the upper pipe and the wire attached to the braid to the bottom pipe. Be certain they do not short together. Cover the exposed connections and wires with hot melt glue or silicone sealant. The end with the remaining plug will connect to the transmitter. Use cable ties for strain relief.